

## X-Pipe Installation For Ford Mustang GT PN 60513



These instructions have been written to help you with the installation of your Borla Performance Exhaust System. Please read this document completely before beginning the installation of your system.

Please compare the parts in the box with the bill of materials provided to assure that you have all the parts necessary for this installation.

To ensure this part number fits your specific model year, please visit our website for the latest model year listings at [www.BORLA.com](http://www.BORLA.com).

**Thank you for purchasing a Borla Performance X-Pipe.**

**This Borla Performance X-Pipe (Part number 60513) is designed for the Ford Mustang GT equipped with a 5.0L V8 engine w/ automatic or manual transmissions and GT500 with 5.4L S/C engine w/ manual transmission.**

***NOTE: This X-Pipe is a direct replacement for the factory H-Pipe. Cutting is required for the GT500.***

Borla Performance Industries recommends that an exhaust shop or professional after market parts installer perform the installation of this system. However, if you decide to perform the installation on your own it is recommended that two people are used. This installation should not be performed by one person due to the risk of injury. Ensure the installers use all under car safety precautions including eye protection.

***Please take time to read and understand the following...***

By installing your Borla Performance X-Pipe, you indicate that you have read this document and you agree with the terms stated below.

It is the responsibility of the purchaser to follow all installation instruction guidelines and safety procedures supplied with your Borla Performance X-Pipe

Borla Performance Industries assumes no responsibility for damages occurring from misuse, abuse, improper installation, improper operation, lack of responsible care, or all previously stated reasons resulting from incompatibility with other manufacturer's products and/or systems.

Included with your Borla Performance X-Pipe is a warranty card. Please read it carefully before you begin any work on your vehicle. If you should have any questions regarding our warranty policy, installation, or any other matter pertaining to your new Borla Performance X-Pipe, please give us a call at the number provided on the warranty card.

**Minimum Required Tool List:**

**TOOLS:**

- 1 3/8" Drive Ratchet
- 2 3/8" Drive Extension 3"
- 3 15mm Deep Well Socket
- 4 Socket extensions (access cat-pipe front flange bolts)
- 5 Pry Bar
- 6 Flat blade screwdriver

**SHOP SUPPLIES:**

- 1 Spray Lubricant

**Borla Performance X-Pipe Bill of Materials**

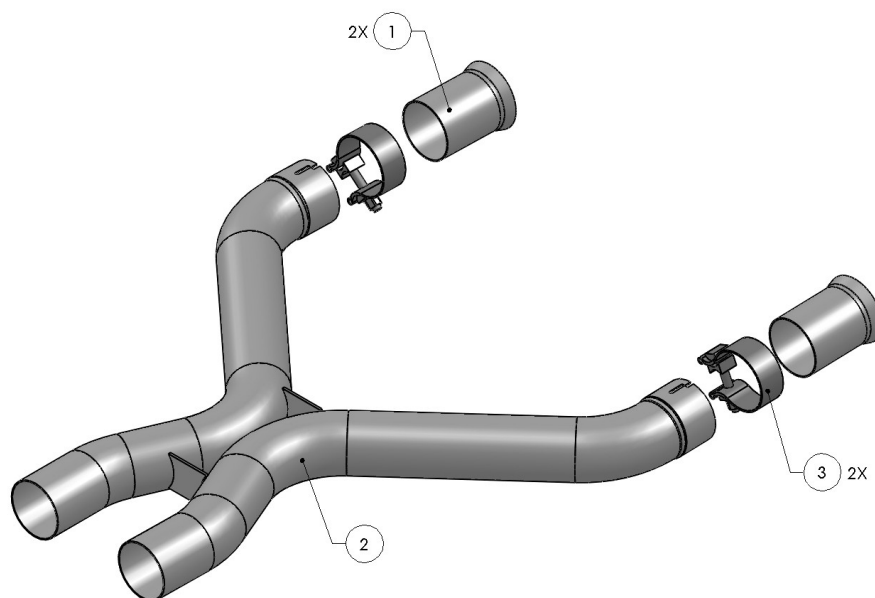

ITEM NO.	QTY.	PART NO.	DESCRIPTION
1	2	27193	FLARED NIPPLE: $\varnothing$ 2.75 O.D. X 3.75" (FROM 80030)
2	1	54269	X-PIPE ASSEMBLY
3	2	90116	S/S ACCUSEAL CLAMP $\varnothing$ 2.75

**Caution!!! Never work on a hot exhaust system. Serious injury in the form of burns can result** If the vehicle has been in use and the exhaust system is hot, allow vehicle to cool for at least 1 hour. Always wear eye protection when working under any vehicle.

*Note: It is our recommendation that you use a hoist or hydraulic lift to facilitate the installation of your new Borla Performance Exhaust System.*

Taking all under car safety precautions, lift the vehicle using a hoist or hydraulic lift. Once this has been done, you may begin the removal of your old exhaust system from your vehicle.

**Note: Before removing the original exhaust system from your vehicle, please compare the parts you have received with the bill of materials provided on the previous page to assure that you have all the parts necessary for the installation of your new Borla Performance Exhaust System.**

## Original System Removal

*Note: With a used vehicle, we suggest a penetrating spray lubricant to be applied liberally to all exhaust fasteners and allowing a significant period of time for the chemical to lubricate the threads before attempting to disassemble.*

1. Loosen (2) front ball-clamps in front of H-Pipe. (See Fig.1)
2. Loosen the (2) Band Clamps shown located just behind the H-pipe. **Do not discard band clamps as they will be used for installation of your new X-Pipe.** (See Fig. 2)
3. Use a stand to support the (2) over-axle pipes.
4. Beginning with the left (driver) side, using a flat blade screwdriver, pull the clip to disengage it from the pipe. Repeat for the right-side. (See Fig. 3)
5. Carefully remove factory H-Pipe from vehicle.
6. \*Ball-clamp must be re-used for installation to factory cat-pipe. Cut clamp from factory H-Pipe as shown. (See Fig.4)

*\*NOTE: Factory Ball-clamp is not used when installing to Borla 17263 Off-Road-Use-Only Long Tube Headers.*

**Warning: Use extreme caution during installation. Torque all fasteners according to manufacturer's torque values and tightening sequence. DO NOT use air impact tools to tighten fasteners on Borla Performance Exhaust Systems. Use of such tools may result in bent flanges or gasket contact areas leading to exhaust leaks.**

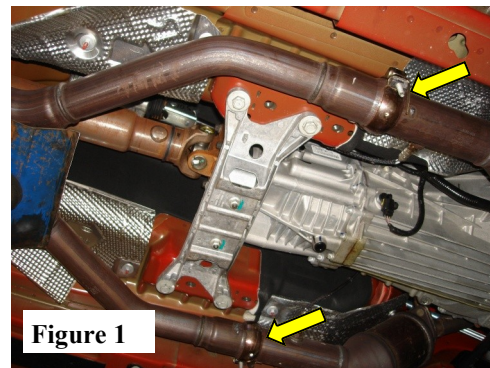

Figure 1

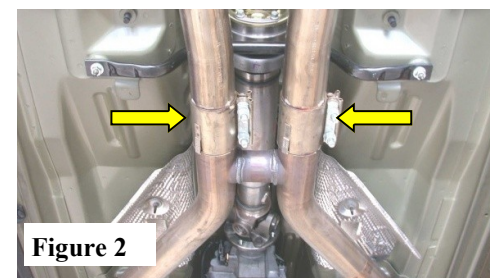

Figure 2

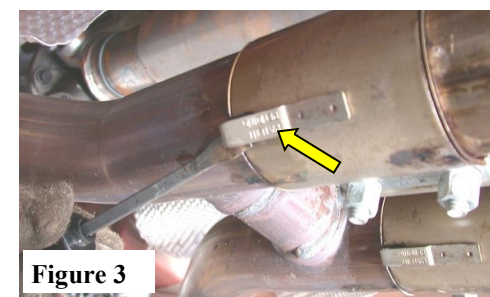

Figure 3

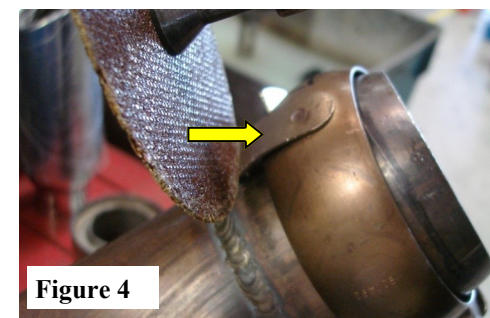

Figure 4



## Borla Performance X-Pipe installation to front factory cat-pipes

**NOTE:** This X-Pipe is designed to replace the factory H-Pipe which may vary width dimension from center to center. You may need to loosen the (4)15mm flange nuts in front of each cat-pipe to adjust. (See Fig.4)

1. Place (2) Accuseal Clamps over each end of X-pipe. Insert (2) Flared Nipple into X-Pipe. Lightly tighten clamps. (See Fig. 5)
2. Place (2) factory Ball Clamps over front cat-pipes. Carefully insert Flared Nipples of X-pipe assembly over flared cat-pipe ends. Position Ball Clamps over pipe and lightly tighten. Position rear section of X-pipe to over-axle pipes and slide (factory) Band Clamps so they're centered over both pipes. (See Fig.6)
3. Check your x-pipe for proper clearance under the vehicle.
4. Once position has been determined to be correct, tighten the Accuseal™ clamps to 32-35 ft. lbs. Tighten factory clamps and cat-pipe flange nuts (if loosened to adjust x-pipe width).
7. Before starting your vehicle, make sure to check all wires, hoses, brake lines, body parts and tires for safe clearance from the exhaust system.
8. Start vehicle and check for any leaks. If any leaks are found, determine cause (such as loose or incorrectly positioned clamp) and repair as necessary.

*Note: When you first start your vehicle after the installation of your new Borla Performance Exhaust System, there may be some smoke and fumes coming from the system. This is a protective oil based coating used in the manufacturing of mandrel bent performance exhaust tubing. This is not a problem and will disappear within a very short period of time after the exhaust has reached normal operating temperatures.*

**Congratulations!!!** You have completed the installation of the world famous Borla Performance Stainless Steel X-Pipe.

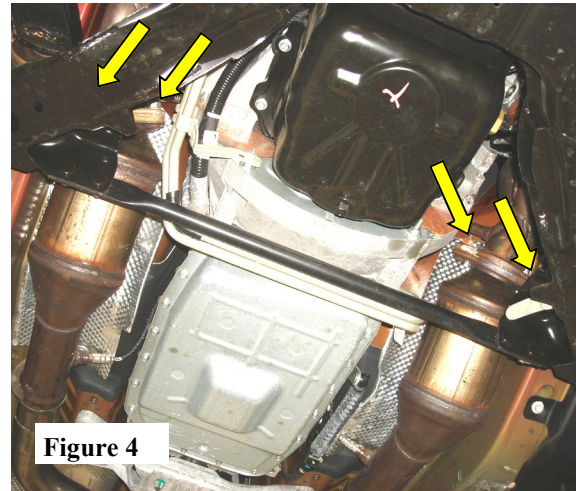

Figure 4

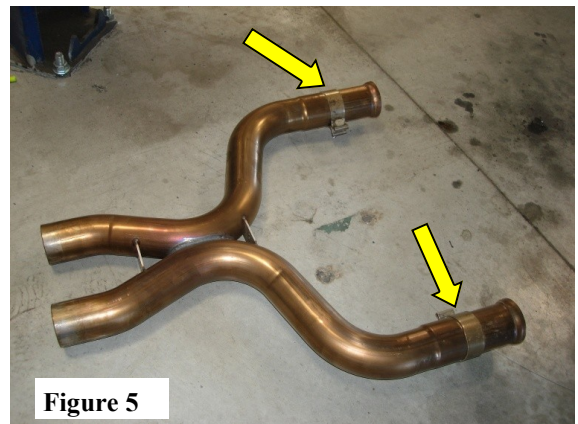

Figure 5

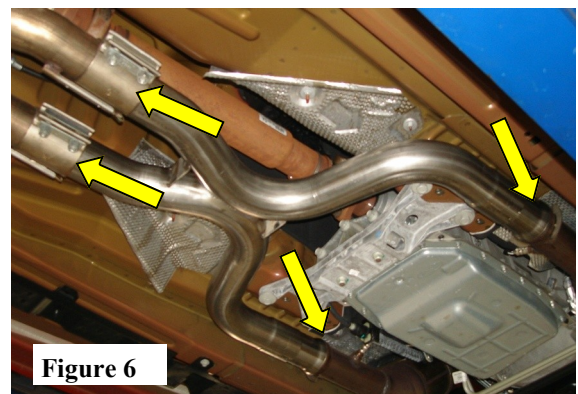

Figure 6